

WASHLET® | NEOREST®

# Visionary Technology Meets Extraordinary Design



hygiene  
mygiene



Issue January 2026

**TOTO**

## WELLNESS

---



### WARM WATER NOZZLE

An individually adjustable wand system with self-cleaning function

## CLEANLINESS

---



### ACTILIGHT

Zirconium coating combined with UV light helps keep the toilet perfectly clean



### EWATER+

Electrolysed water with a cleansing effect



### PREMIST

Mist of water sprayed onto the ceramic before the toilet is used. Makes it more difficult for dirt and waste to accumulate



### TORNADO FLUSH

Highly effective two- or three-jet flush



### RIMLESS DESIGN

Ceramic toilet bowl without hard-to-reach areas along the top edge



### CEFIONTECT

Smooth glaze for a special hygienic ceramic surface

## SUSTAINABILITY

---



### WATER-SAVING

Technologies that save water



### 4,5L FLUSH

Water-saving full flush uses just 4.5l

## COMFORT

---



### AUTO FUNCTIONS

Sensor-based technologies



### HEATED SEAT

Individually adjustable temperature



### DEODORIZER

Filter system to absorb odours



### DRYER

Jet of warm air

## DESIGN

---



### INTEGRATED

Innovative technology meets elegant product design

# CONTENT

- 4 CLEAN SYNERGY
- 6 HISTORY OF WASHLET®
- 8 PRODUCT OVERVIEW

---

## 10 NEOREST® PRODUCT WORLD

- 14 NEOREST® WX2\*
- 16 NEOREST® WX1
- 18 NEOREST® WX1 matt White
- 20 NEOREST® WX1 matt Black

---

## 22 PRODUCT WORLD OF WASHLET®

- 24 WASHLET® RW / RW auto flush with silver trim
- 26 WASHLET® RW / RW auto flush with white trim
- 28 WASHLET® RW / RW auto flush matt White
- 30 WASHLET® RW / RW auto flush matt Black
- 32 WASHLET® SW / SW auto flush
- 34 WASHLET® RX EWATER+ / RX EWATER+ auto flush
- 36 WASHLET® SX EWATER+ / RX EWATER+ auto flush
- 38 WASHLET® RG / RG Lite

---

## 40 EXPERIENCE AND DETAILS

- 42 WELLNESS
- 43 CLEANLINESS
- 56 COMFORT
- 60 SUSTAINABILITY
- 62 DESIGN
- 64 OVERVIEW OF WASHLET® FUNCTIONS
- 66 OVERVIEW OF TECHNICAL DETAILS
- 68 WC / WASHLET® COMBINATIONS
- 70 PLANNING DATA
- 75 WHAT YOU SHOULD KNOW
- 76 IMPRINT

\*NEOREST® WX2 is not available for the UK market.

Let's wash with  
TOTO :  
WASHLET®



# **CLEAN SYNERGY**

**Technology and design**





**EWATER+  
for the wand**  
Cleans the wand  
thoroughly



**EWATER+  
for the bowl**  
Cleans the toilet bowl  
after use and keeps it  
hygienic for longer

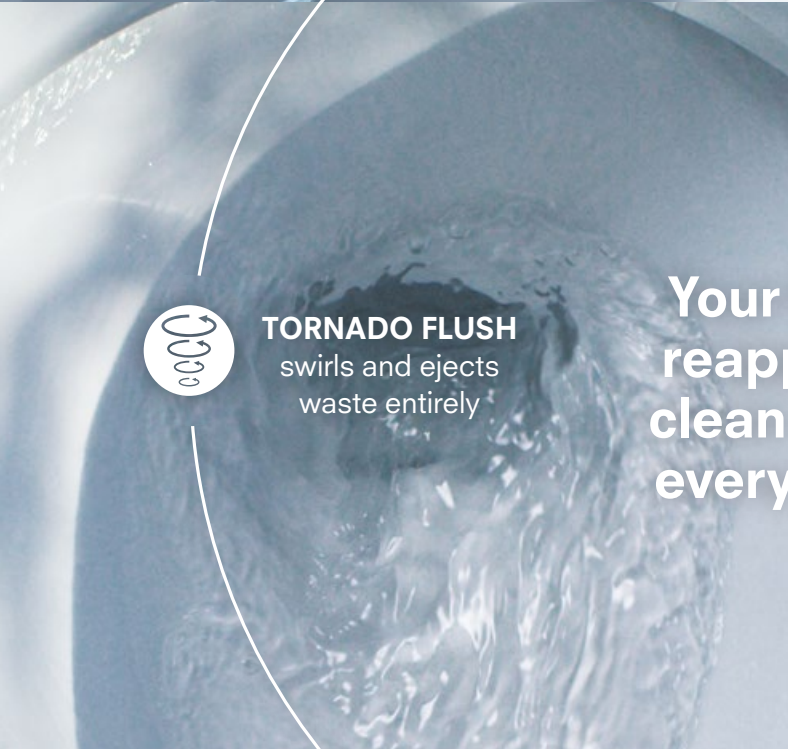

**TORNADO FLUSH**  
swirls and ejects  
waste entirely



**Your toilet  
reappears  
clean anew  
every time.**



**PREMIST**  
prevents waste  
from clinging



**RIMLESS DESIGN**  
Ceramic toilet bowl  
without hard-to-reach  
areas along the  
top edge



**CEFIONTECT**  
forces waste  
to slide down

TOTO  
washLèt®

70  
MILLION

UNITS SOLD  
WORLDWIDE



## The Birth of a Revolutionary Product



1980

# Always Innovating to Spread a Culture of Everyday Comfort and Cleanliness.

Since its launch in the 1980s, WASHLET® has continually evolved through the invention of countless innovative clean technologies. This is also our history of creating – and spreading around the world – a new culture of comfort and cleanliness through the shift from only wiping with toilet paper to cleansing with water. As a result of these efforts,

in 2017 WASHLET® was recognized as the No.1 brand of electric toilet seats with bidet function in the world and in 2022 broke through the milestone of sixty million total units sold. As a worldwide best seller, TOTO will continue pursuing technological innovation to make the lives of people everywhere fresher and richer.



**Exceeds  
20 million  
units**

**2005**



**Exceeds  
40 million  
units**

**2015**



**Exceeds  
60 million  
units**

**2022**

**1998**



**Exceeds  
10 million  
units**

**2011**



**Exceeds  
30 million  
units**

**2019**



**Exceeds  
50 million  
units**

**2025**



**Exceeds  
70 million units**

Note 1: EUROMONITOR INTERNATIONAL. Headquartered in London. Global leader in market surveys with experts in 100 countries.

Note 2: "WASHLET is the world's No.1 brand of electric toilet seats with bidet functions in 2017"

Source: Euromonitor International Limited; in terms of sales volume, based on the custom research conducted in July 2018 – September 2018 in the countries that account for more than 87% share of the global electric toilet seats with bidet functions in 2017.

# NEOREST® & WASHLET®

## An overview of the range.

### NEOREST®

#### NEOREST® WX

The premium solution for discerning tastes.



#### NEOREST® WX2

NEOREST® WX1  
NEOREST® WX1 matt white  
NEOREST® WX1 matt black

from page 14

### WASHLET®

#### RW

Hygiene and design in a curved design.

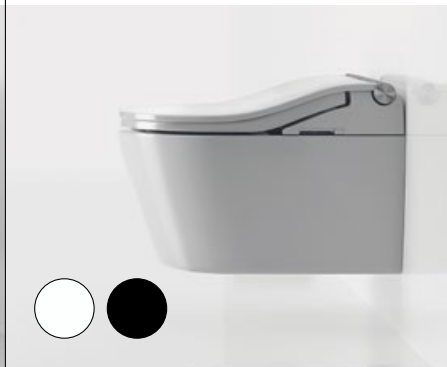

#### WASHLET® RW

with silver trim  
with white trim  
matt white  
matt black

#### WASHLET® RW auto flush

with silver trim  
with white trim  
matt white  
matt black

from page 24

#### SW

Hygiene and design in an angular design.



#### WASHLET® SW

WASHLET® SW auto flush

page 32

## **RX**

A minimalistic,  
curved design option.



**WASHLET® RX EWATER+**

**WASHLET® RX EWATER+ auto flush**

page 34

## **SX**

A simple, angular  
design option.



**WASHLET® SX EWATER+**

**WASHLET® SX EWATER+ auto flush**

page 36

## **RG**

Overall hygiene in  
a compact design.



**WASHLET® RG**

**WASHLET® RG Lite**  
with hidden connections

**WASHLET® RG Lite**  
with side connections

page 38

# NEOREST®

## Luxury at its most beautiful

In their goal to create a premium experience, TOTO brought all tried-and-true technologies together in one elegant design: NEOREST®. Every detail is an expression of perfection – from the touch-free sensor technology and smart surfaces to the harmonious lines that blend seamlessly into every modern bathroom.

NEOREST® WX is much more than just a bidet toilet. It represents a new understanding of comfort, well-being and hygiene – an experience that appeals to all the senses, transforming daily routines into pure relaxation.



THE KINFOLK  
NATHAN WILLIAMS

# PURE LUXURY

**Visionary technology.  
Exquisitely designed for comfort  
and well-being.**

**Born of science and our belief  
in everyday wellness  
to rejuvenate body and mind.**

**NEOREST®. The only one.  
A new form of pure luxury  
brought to life.**





# NEOREST® WX2\*

NEOREST® stands for luxury in every premium bathroom – and NEOREST® WX2 is absolute perfection with its leading-edge technology and extraordinary design. Enjoy the latest generation of TOTO's renowned hygiene and comfort technologies developed over the past 40 years.

Unlike NEOREST® WX1, WX2 includes the self-cleaning ACTILIGHT technology to meet the highest hygiene standards. It uses a photocatalytic process to break down dirt and waste, ensuring a long-lasting clean all by itself.

The newest version of the sensor-based lid that automatically raises when approached has five adjustable precision settings – to optimize this feature for rooms of different sizes.

Even late at night, the bathroom is still a place where people want to feel comfortable. The latest generation of nightlight technology gently fades the light on and off in a soothing, pleasant way.

With harmonious, flowing lines, NEOREST® WX2 has a design that is as impressive as its features – which is why it received the iF Design Award 2023 and Red Dot Design Award 2023. With gentle curves and no harsh edges, NEOREST® WX2 beautifully complements bathrooms of all designs while revealing none of the visionary technologies within.

NEOREST® WX2 is the ideal combination of design and function – for wellness and comfort every day.

- ▶ Overview of functions p 64
- ▶ Planning data from p 70



\*NEOREST® WX2 is not available for the UK market.

# NEOREST® WX1

NEOREST® WX1 meets the highest expectations in hygiene and comfort. Understatedly elegant with organic, flowing curves, it is an ideal addition to the most luxurious of bathrooms.

The smart NEOREST® WX1 looks identical to NEOREST® WX2 when the lid is closed. Its sculptural and flowing design conceals the many technological innovations within and complements all types of bathrooms. WASHLET® unit and the ceramic bowl form a cohesive unit of flowing lines, as if created in a single mould. This design brings all elements into balance while delivering the same high level of hygiene and comfort TOTO is known for.

NEOREST® WX1 includes all of TOTO's latest generation hygiene and comfort technologies except ACTILIGHT. The latest generation of the sensor-based nightlight gently fades the light on and off in a soothing, pleasant way. The newest version of the sensor-based lid that automatically raises when approached has five adjustable precision settings – to optimize this feature for rooms of different sizes.

The innovative and hygienic PREMIST technology sprays the toilet bowl with a fine mist of water to keep dirt and waste from sticking. Electrolysed water automatically cleans the wand after every flush. TOTO's state-of-the-art EWATER+ cleans and helps keep dirt and waste from accumulating over time – for a very hygienic bathroom.

Experience the ideal symbiosis of design and technology with NEOREST® WX1 – for more harmony and wellness every day.

- ▶ Overview of functions p 64
- ▶ Planning data from p 70







# NEOREST® WX1

## matt white

TOTO provides new inspiration for designing sophisticated bathrooms with their new matt white edition of the premium NEOREST® collection. The matt finish gives NEOREST® a strong, distinctive presence in the space.

Matt white stands for purity and aesthetics, reflecting the need for a design that is timelessly minimalist, understatedly elegant and visibly light. Ceramics in matt white are simultaneously modest and extraordinary. With this refined look, NEOREST® WX1 is effortlessly luxurious when combined with coordinating washbasins and faucets.

In addition to the fresh look and feel, the new matt white version also offers a distinctive tactile experience. The velvety smooth surface appeals to the senses, elevating the sense of well-being in the bath. This new colour version opens up so many new opportunities for high-end bathroom design.

The matt white version includes the same comfort and hygiene technologies as all the latest NEOREST® WX1 models.

- 
- ▶ Overview of functions p 64
  - ▶ Planning data from p 70

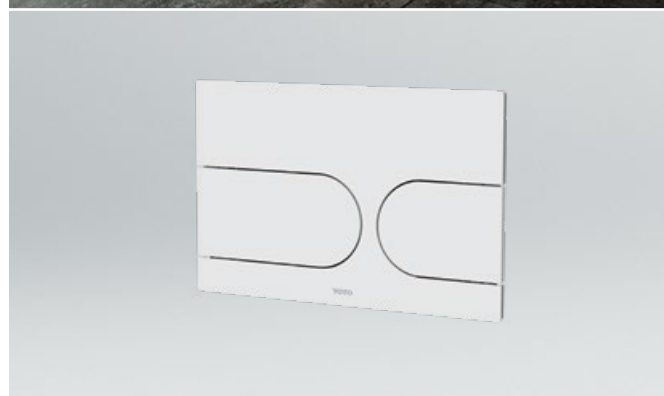

# NEOREST® WX1 matt black

The premium NEOREST® collection in matt black makes a powerful statement in the bath. More than just a colour, it is the “essence of elegance and perfection.” TOTO effectively shows that a fresh look and feel can make technologically sophisticated products truly inspiring.

The matt black version of NEOREST® WX1 reflects design excellence, luxury and elegance unlike any other ceramic colour. The dark finish is expressive and unexpected, adding a strong accent to the bathrooms of tomorrow. Black provides the perfect backdrop for design, lending a particular depth to each space.

The new matt black version also offers a distinctive tactile experience. The velvety smooth surface appeals to the senses, elevating the feeling of well-being in the bath.

The matt black version includes the same comfort and hygiene technologies as all the latest NEOREST® WX1 models.

- 
- ▶ Overview of functions p 64
  - ▶ Planning data from p 70







# washlet®

**Life-changing! This is how people describe the experience of using WASHLET® for the first time. Once they've encountered the soothing comfort of being cleansed with a hygienic stream of water, using just toilet paper will never seem thorough enough.**

## **What is the difference between a standard toilet and WASHLET®?**

A WASHLET® is a shower toilet with an integrated wand jet that cleans the intimate areas with warm water. A remote control makes it possible select various functions and individual settings, like the position and water pressure of the spray, as well as the temperature. Other comfort features include a pre-warmed toilet seat and, depending on the model, a dryer.



**Who is WASHLET® made for?**

Hygiene isn't a question of age, living conditions or origin. Everyone has their own standards of hygiene – and they get more important when the most intimate parts of the body are involved. As such, a shower toilet is perfect for anyone who cares deeply about personal hygiene and wants to feel fresh throughout the entire day.

**Why is WASHLET® the better choice?**

Whether our hands, face or body – we always use water on our skin to ensure the best hygiene. Why not do the same when using the toilet? WASHLET® models clean the intimate areas gently and naturally with warm water – for a pleasant, fresh feeling any time of the day.



# WASHLET® RW / RW auto flush with silver trim

WASHLET® RW has an impressively timeless design and is an outstanding value for the price. Elegant and versatile, it blends seamlessly into bathrooms of all styles while offering all hygiene and comfort features.

The seamless seat ring on the RW is even easier to clean. It's also possible to easily remove WASHLET® from the toilet bowl for thorough cleaning. The silicone-based Clean Resin material used for the WASHLET® unit, seat and wand make it difficult for waste and dirt to accumulate.

Of course, WASHLET® RW with silver trim comes equipped with all of the characteristic hygiene and comfort features: warm water spray, heated seat, odour-absorbing deodoriser and dryer. In addition, the EWATER+ feature cleans WASHLET® wand jet and the toilet bowl with electrolysed water after use.

WASHLET® RW with silver trim is also available with auto flush. This model offers an additional automatic flush feature in combination with TOTO's frame system. Both versions can be combined with a wall-hung or floorstanding TOTO toilet.

- ▶ Overview of functions p 64
- ▶ Possible combinations p 68
- ▶ Planning data from p 70

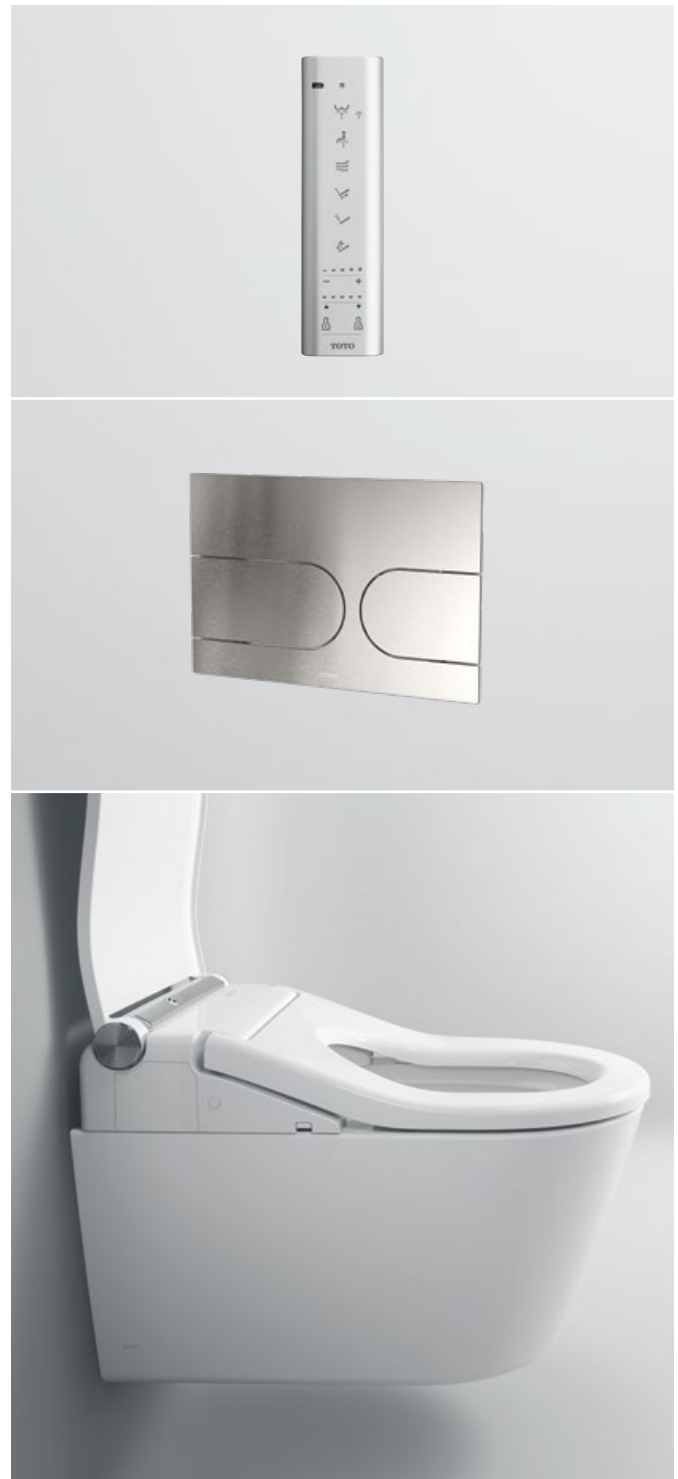

# WASHLET® RW / RW auto flush with white trim

TOTO has introduced a new, stylish design of the bestselling WASHLET® RW all in white. This version of the RW has white trim, a matching white remote control and white push plate – the perfect choice for those who want to bring the lightness of pure white into the bath.

The RW versions with the white and silver trim are equipped with the same technologies. They both offer the familiar hygiene and comfort features people associate with WASHLET®: the warm water spray, heated seat, odour-absorbing deodoriser and dryer. They also include EWATER+, which thoroughly cleans the wand and toilet bowl with electrolysed water. The RW's seamless seat ring allows for easy cleaning. Removing WASHLET® from the toilet is simple, making it possible to clean the entire area quickly. The silicone-based Clean Resin material used for the WASHLET® unit, seat and wand make it difficult for waste and dirt to accumulate.

WASHLET® RW with white trim is also available with the auto flush feature when combined with TOTO's frame system. Both versions are compatible with wall-hung or floorstanding TOTO toilets.

- ▶ Overview of functions p 64
- ▶ Possible combinations p 68
- ▶ Planning data from p 70







# WASHLET® RW / RW auto flush matt white

TOTO is bringing fresh inspiration to bathroom design with its matt white version of WASHLET® RW. The reimagined RW exudes pure, minimalist elegance with a new tactile experience. Understated and refined, the RW radiates quiet luxury.

Of course, the matt white RW model has the familiar hygiene and comfort features people associate with WASHLET®: the warm water spray, heated seat, odour-absorbing deodoriser and dryer. It also includes EWATER+, which thoroughly cleans the wand and toilet bowl with electrolysed water. The RW's seamless seat ring allows for easy cleaning. Removing WASHLET® from the toilet is simple, making it possible to clean the entire area quickly.

WASHLET® RW in matt white is also available with the auto flush feature when combined with TOTO's frame system.

- 
- ▶ Overview of functions p 64
  - ▶ Planning data from p 70

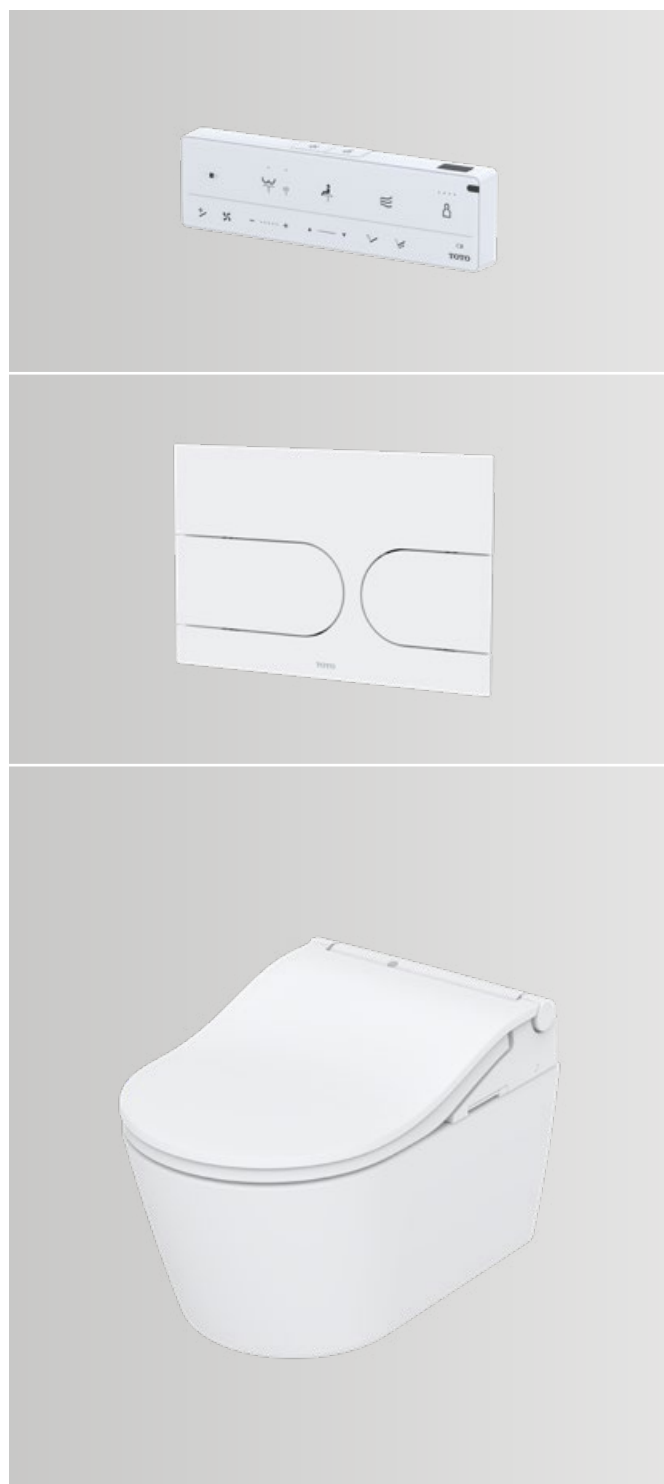

# WASHLET® RW / RW auto flush matt black

The matt black version of WASHLET® RW reflects design excellence, luxury and elegance unlike any other ceramic colour. The dark finish is expressive and unexpected, adding a strong accent to the bathrooms of tomorrow. Black provides the perfect backdrop for design, lending a particular depth to each space.

Of course, the matt black RW model has the familiar hygiene and comfort features people associate with WASHLET®: the warm water spray, heated seat, odour-absorbing deodoriser and dryer. It also includes EWATER+, which thoroughly cleans the wand and toilet bowl with electrolysed water. The RW's seamless seat ring allows for easy cleaning. Removing WASHLET® from the toilet is simple, making it possible to clean the entire area quickly.

- 
- ▶ Overview of functions p 64
  - ▶ Planning data from p 70







# WASHLET® SW / SW auto flush

The SW has the same features as its predecessor model, the curved RW. The only difference between the two models is their design.

In addition to the well-known hygiene and comfort features, WASHLET® SW also has a seamless seat which makes it even easier to clean. It's also possible to easily remove WASHLET® from the toilet for thorough cleaning. A silicone-based material is used for WASHLET® itself (so-called „Clean Case“), which makes it more difficult for dirt to accumulate.

Of course, WASHLET® SW is equipped with all of the characteristic hygiene and comfort features: warm water spray, heated seat, odour-absorbing deodoriser and dryer. In addition, the EWATER+ feature cleans the wand jet and toilet bowl with electrolysed water after use.

WASHLET® SW is also available with auto flush. This model offers an additional automatic flush feature in combination with TOTO's frame system.

- ▶ Overview of functions p 64
- ▶ Planning data from p 70



# WASHLET® RX EWATER+ / RX EWATER+ auto flush

WASHLET® RX EWATER+ combines elegant design, featuring an exclusive urea resin seat, with TOTO's consistently high standards of hygiene.

The RX EWATER+ model also includes an adjustable warm water spray, which is heated by a continuous-flow water heater to ensure unlimited warm-water cleansing. It also has a heated seat, odour-absorbing deodoriser and the PREMIST feature, which automatically sprays a fine mist of water onto the toilet bowl before use. This helps wash away anything that might stick to the surface. The wand automatically cleans itself after every use with EWATER+.

Like all WASHLET® models, it's possible to save preferred spray settings for two users on the remote control and access them at the touch of a button.

WASHLET® RX EWATER+ is also available with auto flush. This model offers an additional automatic flush feature in combination with TOTO's frame system.

---

► Overview of functions p 64

► Planning data from p 70



GREEN  
GOOD DESIGN  
AWARD  
2018







# WASHLET® SX EWATER+ / SX EWATER+ auto flush

WASHLET® SX EWATER+ has the same features as the RX EWATER+. The only difference is the shape. The angular WASHLET® SX EWATER+ has an elegant, slim urea resin seat and is equipped with TOTO's proven technologies.

The SX EWATER+ includes the familiar comfort and hygiene features TOTO is known for: the heated seat, adjustable warm water spray (with continuous-flow water heater for unlimited cleansing), odour-absorbing deodoriser and PREMIST function. The SX EWATER+ also uses the cleansing EWATER+ feature to automatically clean the wand jet after each use.

Like all WASHLET® models, it's possible to save preferred spray settings for two users on the remote control and access them at the touch of a button.

WASHLET® SX EWATER+ is also available with auto flush. This model offers an additional automatic flush feature in combination with TOTO's frame system.

- 
- ▶ Overview of functions p 64
  - ▶ Planning data from p 70





# WASHLET® RG / RG Lite

This WASHLET® is available in the variants RG and RG Lite. The two versions are identical in design and simply differ in the extent of technologies. With a depth of 540 mm these two WASHLET® models are compact enough to fit even in smaller bathrooms.

The RG Lite is available with hidden and side connections and can be combined with a wide range of TOTO WCs in the version with side connections.

Of course, the user of the RG Lite can also rely on TOTO's extensive hygiene technologies. The heated seat and the individually adjustable water nozzle offer the user comfort and a long-lasting feeling of freshness. And to be protected from dirt, the WASHLET® nozzle is also positioned behind a flap above the WC ceramics in this model. Furthermore, the automatic pre-cleaning of the nozzle with water and the post-cleaning with EWATER+ ensures optimal hygiene for every user.

The WASHLET® RG additionally features the PREMIST function, which sprays the wc ceramics with a fine mist of water before use. Also integrated is a deodoriser that filters unpleasant odours.

- ▶ Overview of functions p 64
- ▶ Possible combinations p 68
- ▶ Planning data from p 70



**Every moment of every day,  
the experience of life arising clean,  
comfortable and always inviting.**

Constantly at work, automated technologies maintain hygienic conditions, keeping surfaces clean and providing a place that is inviting and comfortable.





## WARM WATER NOZZLE

The precise, adjustable, stream keeps you clean. And it's always pleasantly warm.

Users can choose from more than just the Comfort and Front wash sprays. Additional functions allow users to personalise their cleansing experience. The focus is always on the gentle, comfortable spray that uses as little water as possible.

## Cleansing spray patterns

### Rear Cleansing

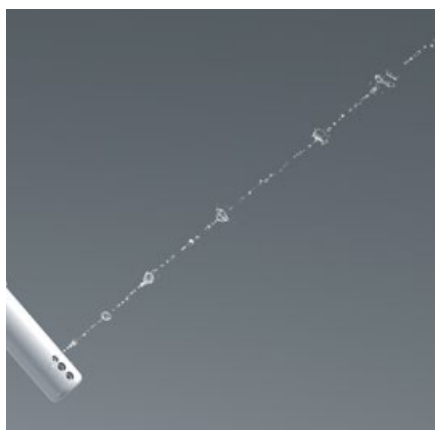

Large air-filled water droplets offer complete cleansing and a comfortable sensation with minimal water use.

### Rear Soft Cleansing



Plentiful shower of water gives a gentle sensation for complete cleansing over a wider area.

### Front Cleansing



Gentle dispersion of large water droplets ensure intimate cleansing in the most comforting way.

## Additional functions

### Oscillating



The back-and-forth movement of the wand ensures thorough cleansing of the entire area.

### Pulsating



The selected spray pattern is switched to pulsing mode.

### Wand Position Adjustment



It's easy to adjust the position of the wand jet to your individual needs.

### Water Pressure Adjustment



Select from five levels of water pressure.



**EWATER+** for the wand

**CLEAN SYNERGY**

**Electrolysed water  
with a cleansing effect**

The wand nozzle cleans  
itself automatically inside  
and out with EWATER+.

**After each use, the WASHLET® wand automatically washes itself with EWATER+. This thorough cleaning occurs inside the wand as well as all around the exterior. Even when the WASHLET® is not being used, the wand periodically cleans itself to ensure constant hygienic conditions.**

### Long lasting Cleaniness



Survey: Study the effectiveness of EWATER+ by comparing the state of cleanliness of wands self-cleaned with EWATER+ versus those that are not. No additional cleaning was allowed. Survey period: Two months (September–October 2017). Subjects: Families of four. (Results vary according to usage, environmental conditions, and product type. All data collected by TOTO.)

### Always keeping Conditions clean



Made of high-quality waste-resistant resin and automatically sprayed with EWATER+ after each use, the wand is extremely resistant to waste and stains. What's more, the wand attaches to the seat, not the bowl, so waste is less likely to even reach it. Though the wand is self-cleaning, you will appreciate how easily you can reach it and wipe it spotless.

### Self-cleaning, even inside the wand jet

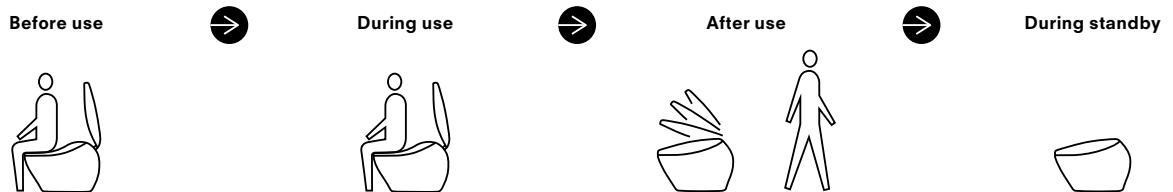

Self-cleans with water



Self-cleans with water



Self-cleans inside and out with EWATER+



Self-cleans inside with EWATER+



**EWATER+** for the bowl

**CLEAN SYNERGY**

**Cleans the bowl  
after use**

Electrolyzed water  
reduces waste.

**EWATER+ cleans areas of the toilet bowl where waste tends to accumulate, which could cause hard-to-remove stains. Every day, EWATER+ provides the peace of mind that dirt has nowhere to hide.**

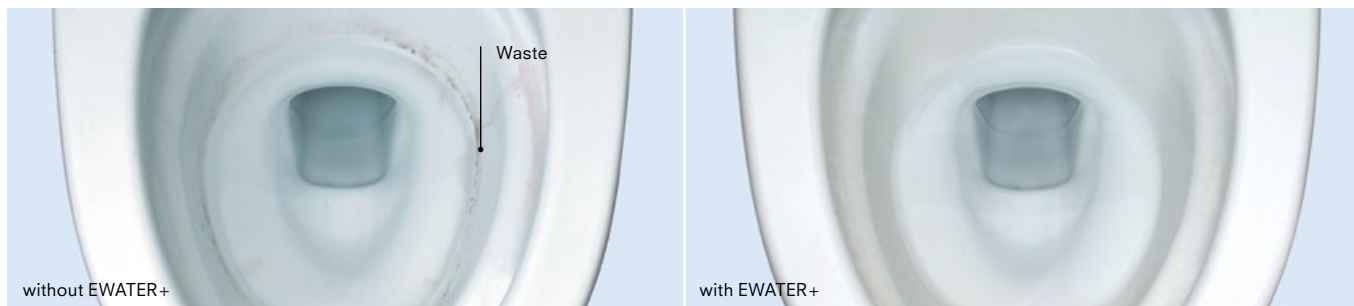

Survey: Study the effectiveness of EWATER+ by comparing the state of cleanliness of toilet bowls that receive no cleaning versus toilet bowls that are self-cleaned with EWATER+. No additional cleaning was allowed. Survey period: One month (February–March 2017). Subjects: Families of four. (Results vary according to usage and environmental conditions. All data collected by TOTO.)

### How EWATER+ cleans

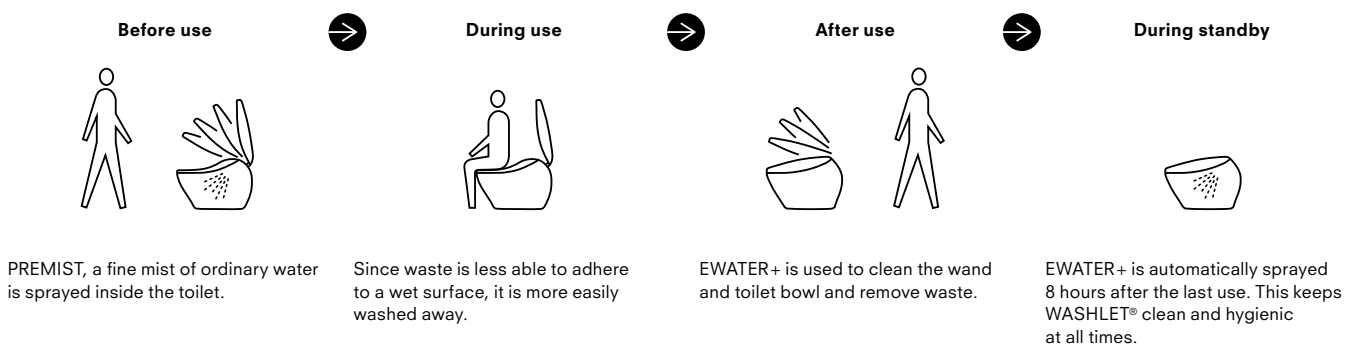

### What is EWATER+?

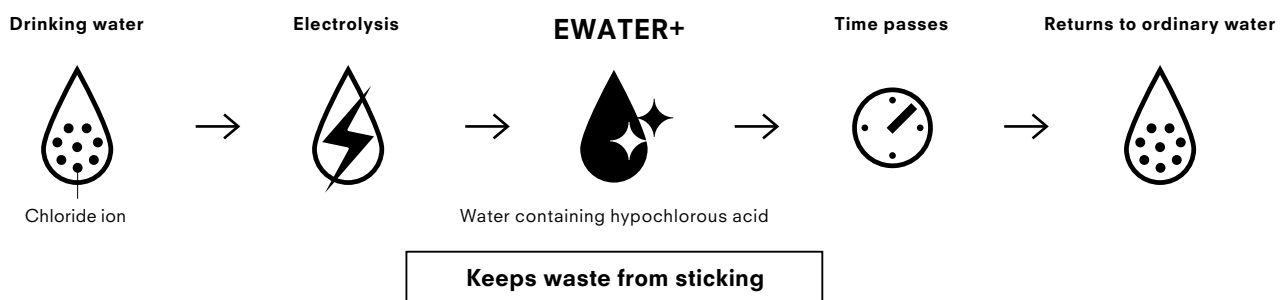

Produced by electrolysis of the chloride ion in drinking water, It is completely free of chemicals and cleaning agents. Over time EWATER+ returns to its original state of ordinary water, making it completely environmentally friendly.



## CEFIONTECT

**CLEAN SYNERGY**

**Forces waste  
to slide down**

Ultra-smooth ceramic  
leaves nowhere  
for waste to cling.

**CEFIONTECT is an ultra-smooth ceramic glaze that coats the toilet bowl. Its microscopic surface ridges are far smaller than waste particles, leaving no place for waste to gain a foothold. Extremely durable, CEFIONTECT is designed for enduring beauty and cleanliness.**

**Extremely smooth glaze**



No CEFIONTECT

CEFIONTECT

Conventional ceramic may appear perfectly smooth to the eyes, but has gaps where waste, mold and bacteria hide. At just one millionth of a millimeter, CEFIONTECT's surface ridges are much tinier than waste particles.

**CEFIONTECT is hydrophilic**

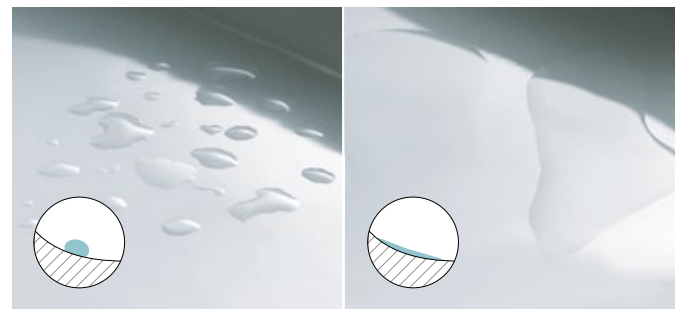

Water hydrophobic

Water hydrophilic

Hydrophilic describes organisms and materials that attract water. CEFIONTECT is hydrophilic. Water spreads easily over the toilet bowl, so waste particles easily wash away.

**What makes CEFIONTECT so durable?**

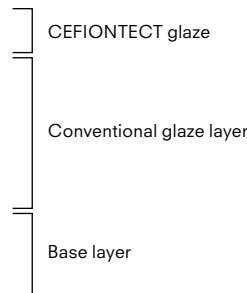
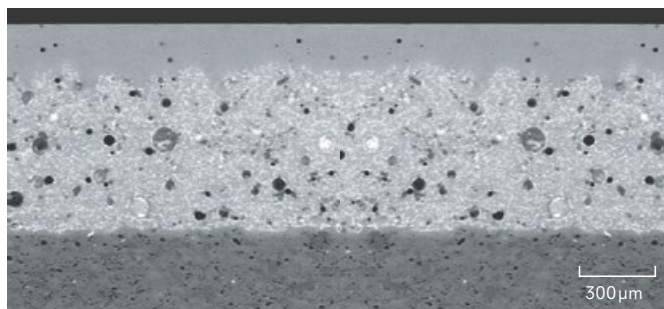

CEFIONTECT toilet micrograph \* 1 μm=0.001 mm

Glass layers are burned onto conventional glaze, making CEFIONTECT an extremely durable material.



## **TORNADO FLUSH**

**CLEAN SYNERGY**

**Swirls and ejects  
waste entirely**

360° cleaning power  
reaches every spot  
using less water.

**TORNADO FLUSH cleans more effectively – but is also quieter, and uses less water than conventional toilets. The powerful flush creates a whirlpool that cleans every inch of the toilet bowl without missing a spot.**



## TORNADO FLUSH

**Powerful flush for thorough cleanliness**



TORNADO FLUSH reaches every inch of the toilet bowl – all the way to the edge. The water is propelled into the bowl, creating a whirlpool that harnesses the power of the water for thorough cleansing. The high-quality ceramic used in TOTO toilets make this innovative technology possible.



## RIMLESS

**Rimless ceramic toilet bowls**



The RIMLESS design not only leaves no place for waste and germs to hide. It also makes for a much easier to clean toilet.

## Hygiene, setting new standards.

### Hygiene report

TOTO commissioned a comparative study\* of a conventional toilet and the TOTO toilets with TORNADO FLUSH. The results showed that these TOTO toilets are especially suitable for use in hygiene-critical areas, such as hospitals, care facilities and heavily used toilets. Another finding showed that the TORNADO FLUSH on the rimless TOTO toilet eliminated all waste and organisms from the surface with the very first flush. To read the complete report, go to: <http://gb.toto.com>

### Excerpt from report

“It was possible to thoroughly clean the ceramic surface and eliminate all soiled areas on the ceramic surfaces of the TOTO toilets quickly, easily and without great effort.

For this reason, only very little time is needed for cleaning.”  
“...The TOTO CW762Y and CW132Y rimless toilets [...] are superior to the conventional toilet with rim and standard flush.”

**Prof. Dr. med. Klaus-Dieter Zastrow**  
Doctor for hygiene and environmental medicine



## PREMIST

### CLEAN SYNERGY

**Prevents waste  
from clinging**

A film of water  
keeps waste  
from clinging.

**PREMIST automatically sprays water over the surface of the inner toilet bowl before every use. Due to the ceramic's hydrophilic nature, waste washes away more easily.**

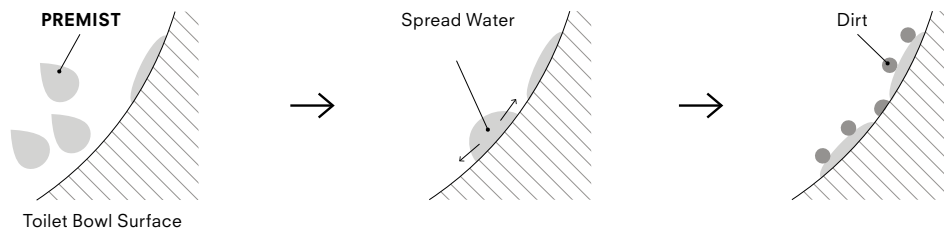

## Guaranteed cleanliness

### Covered wand jet



The wand jet disappears completely under a hygienic flap, keeping it free of faeces and urine.

### Wand jet position

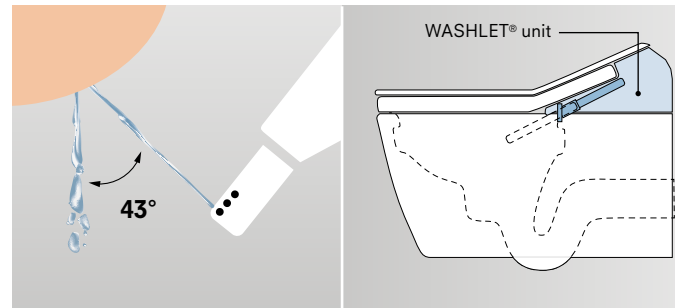

The jet extends at an angle, which keeps it from getting dirty. The soiled water falls directly into the toilet bowl at an angle of 43–53°, which keeps the jet clean.

### Clean resin for nozzle

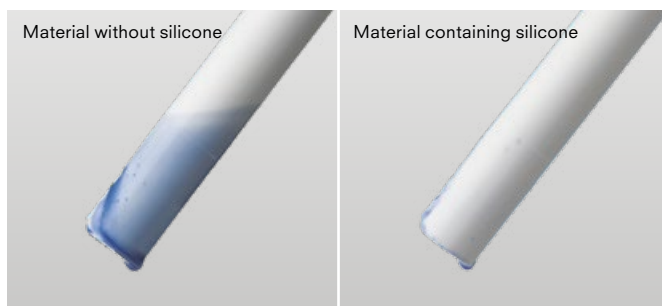

The wand jet is coated with a silicone-based material with dirt-resistant properties, which keep the jet clean in combination with its self-cleaning feature.

### Clean resin for the toilet seat



The toilet seat also consists of a special silicone-based material with dirt-resistant properties.

### Clean Case – Clean resin for case

Like WASHLET® seat and nozzle, several WASHLET® models also feature WASHLET® unit made of special silicone-based material with dirt-repellent properties.

### Seamless toilet seat

While WASHLET® seat consists of several parts, including the heating coil in the middle, the seat itself is seamless. This gives dirt or waste less space to attack.



## ACTILIGHT

The photocatalytic glaze has the natural power to keep the toilet immaculate, making it the ultimate cleaning technology.

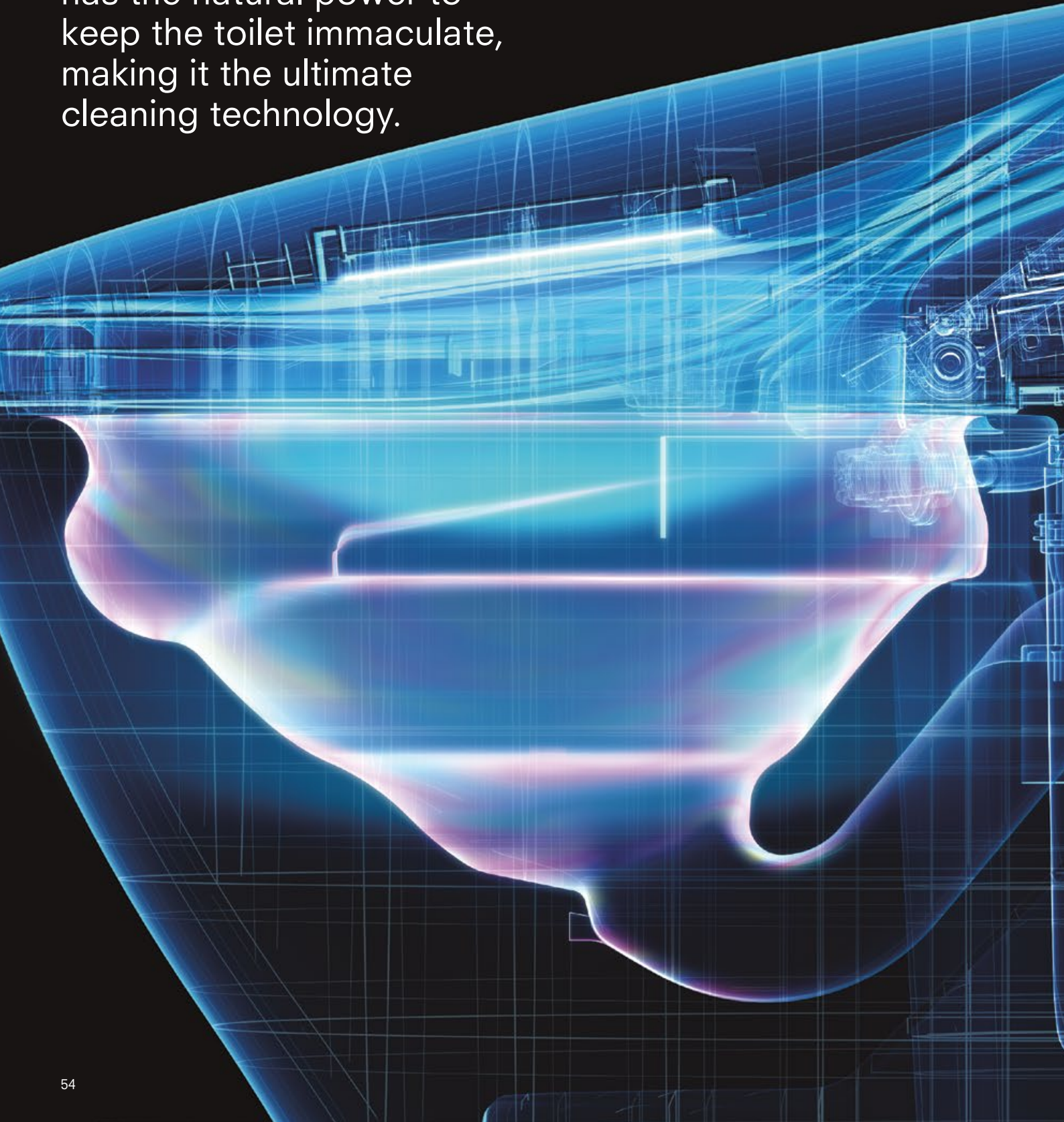

**ACTILIGHT in the NEOREST® WX2\* elevates toilet cleaning to an extraordinary new dimension. This extraordinary technology shines ultraviolet light on a toilet bowl featuring a titanium dioxide coating. This triggers a photocatalytic process that achieves a whole new level of hygiene.**

### State-of-the-art materials

Titanium dioxide attracts water to the surface of the toilet bowl, setting the stage for photocatalysis. The toilet bowl's photocatalytic glaze layer also contains zirconium oxide, which provides its extreme durability.

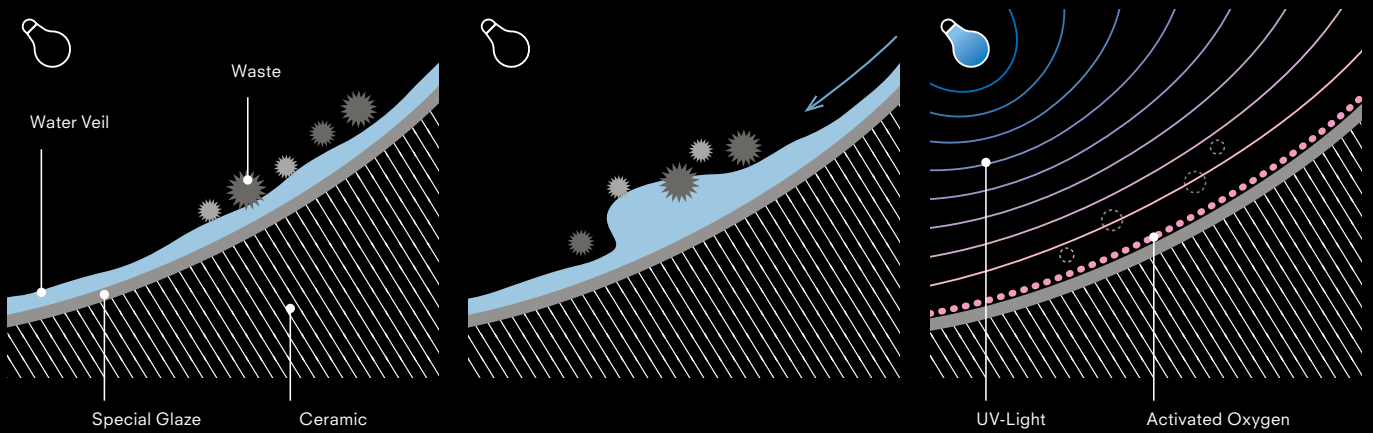

### Operates 24 hours a day to maintain hygienic conditions



\*NEOREST® WX2 is not available for the UK market.



**All NEOREST® and some WASHLET® models offer the following comfort features – for the most user-friendly experience possible.**

All NEOREST® models include these comfort features – and some WASHLET® models as well. For a list of the technologies and features available in each model, see our “Overview of Functions” table on page 56/57.



**Sensor-activated lid**



Eliminating the need to touch the toilet surfaces, the lid of the NEOREST® WX models or WASHLET® RW and SW automatically opens and closes when the toilet is approached and departed.



**Sensor-activated flush**



No need to touch buttons or handles and never worry about someone forgetting to flush – it’s automatic after each use. Applies for NEOREST® WX1 and WX2\* as well as the auto flush versions of WASHLET® RW, SW, RX and SX.



**Heated seat**



The remote control regulates the WASHLET® seat temperature and switches the heated seat on and off. Especially comfortable and beneficial in the winter, the heated seat also has an energy-saving feature.



**Dryer**



The individually adjustable dryer follows the warm water spray to ensure a dry, clean overall feeling.



**Deodoriser**



Highly effective deodorizing automatically takes place inside the toilet bowl both during and immediately after use, leaving no disturbing odors.



**Night light**



Subdued lighting switches on when the NEOREST® WX1 and WX2\* or WASHLET® RW and SW is approached, so users do not have to disturb themselves at night with a bright bathroom light.



**Remote control**



The remote control makes all functions easy to use and adjust. All models include a memory function to save preferred settings for two or four users. It is also possible to flush the toilet using the remote control on several models.



**Continuous-flow water heater**

All NEOREST® and WASHLET® models feature a continuous-flow water heater to provide unlimited water for intimate cleansing.

\* NEOREST® WX2 is not available for the UK market.



## AUTO FLUSH

for all NEOREST®  
and selected  
WASHLET® models



**TOTO's frame system makes it possible to add an automatic flush feature to the NEOREST® WX models and selected, special WASHLET® models – for even greater hygiene thanks to less contact while using the toilet.**

## **Touch-free flush**

The frame system is available for all NEOREST® and specially designed WASHLET® models with automatic flush\*:

- NEOREST® WX2\*\*
- NEOREST® WX1
- NEOREST® WX1 matt White
- NEOREST® WX1 matt Black
  
- WASHLET® RW auto flush with silver trim
- WASHLET® RW auto flush with white trim
- WASHLET® RW auto flush matt White
- WASHLET® RW auto flush matt Black
- WASHLET® SW auto flush
- WASHLET® RX EWATER+ auto flush
- WASHLET® SX EWATER+ auto flush

The automatic flush is activated once the seat sensors register that the user has stood up. The "small" 3-litre flush is activated if the user has been seated for 6 to 30 seconds, and the "large" 4.5-litre flush for more than 30 seconds. The automatic flush is not activated if the user sits for fewer than 6 seconds.



\* For detailed information about required parts, please see our price list or our website: [eu.toto.com](http://eu.toto.com).

\*\* NEOREST® WX2 is not available for the UK market.

NEOREST

## ENERGY SAVER

**Save energy during  
times of non-use**

Manual and automatic  
energy saving feature.



**TOTO WASHLET® feature two types of energy savers. Energy saver timer allows you to set a time at which the shower toilet is set to stand-by mode. With energy saver auto, it records its users' habits and automatically selects the best time for stand-by mode.**

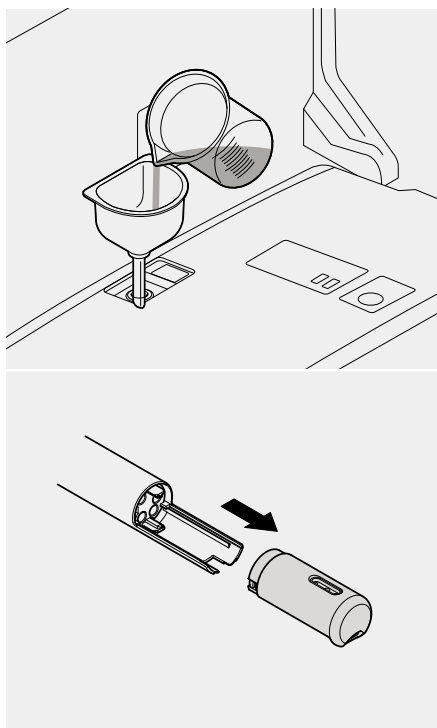

### **Decalcification**

You can decalcify all NEOREST® and WASHLET® models with the automatic decalcifying programme and the removable wand jet.

For the automatic decalcifying programme simply fill with a TOTO-recommended, conventional decalcifying agent and start the decalcifying programme.

### **EN 1717 standard stands for drinking water safety**

Toilet water is rated as a hazard class 5 liquid in accordance with EN 1717. This standard describes the necessary precautions that a device must fulfil in order to secure the quality of drinking water. All TOTO shower toilets are intrinsically safe and have a family A, type B respectively type D backflow prevention. This keeps non-potable water from flowing back into drinking water systems without any additional installation required.



All WASHLET® are WRAS certified and meet the high standards of UK water regulations. With its environmentally friendly philosophy, this certification also confirms TOTO's sustainable responsibility at a local level.

### **Sustainable cleansing**

The NEOREST® WX models and the WASHLET® RW and SW models spray the cleansing EWATER+ onto the extra smooth ceramic toilet bowl to make it more difficult for waste and bacteria to accumulate. All models clean the wand with EWATER+ after use. Free of chemicals and cleansers, EWATER+ can be released back into the water cycle without worry as H<sub>2</sub>O.



\*NEOREST® WX2 is not available for the UK market.



## INTEGRATED

Innovative  
technology  
meets elegant  
product design



WASHLET® RX EWATER+ with WC RP

All NEOREST® and WASHLET® models and TOTO toilets unite innovative technologies and aesthetic design. The goal: to provide users with maximum hygiene and comfort. The result: a holistic wellness experience for the body and soul.



Product details of TOTOs WASHLET® RW with WC RP and WASHLET® SW with WC SP

## Toilet and WASHLET® combinations that are truly stunning from every angle

TOTO's minimalistic product design is aligned with its technology. All technical components are integrated within the product. You know that they are there, and can use them – but cannot see them. To achieve the best look, we combine most WASHLET® models with a compatible TOTO toilet that makes it possible to run the needed cable and water connections through the ceramic.

## Award-winning design

TOTO and WASHLET® stand for excellent design as shown by the many prominent product awards received in recent years (excerpt):



### Green Good Design Award

NEOREST® WX1 and WX2\*, WASHLET® RW, SW, RX EWATER+, SX EWATER+, RG, RG Lite



### red dot Design Award

NEOREST® WX1 and WX2\*

























### iF Design Award

NEOREST® WX1 and WX2\*, WASHLET® RX and RW (with RP toilet), WASHLET® SX and SW (with SP toilet)



\*NEOREST® WX2 is not available for the UK market.







# Overview of functions

		NEOREST® WX2*	NEOREST® WX1	
				
HYGIENE	 ACTILIGHT	•		
	 EWATER+ for the bowl	•	•	
	 EWATER+ for the wand	•	•	
	 PREMIST	•	•	
	 Self-cleaning wand jet	•	•	
	 Clean Nozzle: Clean resin (silicone-based alloy) for nozzle	•	•	
	 Clean Seat: Clean resin (silicone-based alloy) for toilet seat	• 4)	• 4)	
	 Clean Case: Clean resin (silicone-based alloy) for case	• 4)	• 4)	
	 Seamless seat ring	•	•	
	 CEFIONTECT	•	•	
	 RIMLESS DESIGN	•	•	
	 TORNADO FLUSH	•	•	
	 Decalcifying function	• 1) 2)	• 1) 2)	
CLEANSING	 Comfort spray rear	•	•	
	 Comfort spray rear soft	•	•	
	 Comfort spray front wash	•	•	
	 Oscillating spray	•	•	
	 Massaging spray	•	•	
	 Adjustable water pressure	•	•	
	 Adjustable position	•	•	
COMFORT	 Night light	•	•	
	 Sensor-activated flush	•	•	
	 Sensor-activated lid	•	•	
	 Soft-closing seat	•	•	
	 Remote control	•	•	
	 DRYER with adjustable temperature	•	•	
	 HEATED SEAT with adjustable temperature	•	•	
	 DEODORISER – Air-cleaning filter system	•	•	
	 Memory function for several persons	•	•	
	 Continuous-flow water heater	•	•	
	 Energy Saver Timer	•	•	
	 Energy Saver Auto	•	•	



# Overview of technical details

		NEOREST® WX2*	NEOREST® WX1	
				
WARM WATER SPRAY	Comfort spray flow rate	0.27 to 0.43 l/min	0.27 to 0.43 l/min	
	Soft flow rate	0.27 to 0.43 l/min	0.27 to 0.43 l/min	
	Lady shower flow rate	0.29 to 0.43 l/min	0.29 to 0.43 l/min	
	Continuous-flow water heater	●	●	
	Warm water supply	unlimited	unlimited	
	Adjustable water temperature	30 to 40 °C	30 to 40 °C	
COMFORT	Heated seat, individually adjustable temperature	28 to 36 °C	28 to 36 °C	
	Deodoriser – Filter system performance	0.16m <sup>3</sup> /min	0.16m <sup>3</sup> /min	
	Dryer with adjustable temperature	35 to 60 °C approx. 0.25m <sup>3</sup> /min	35 to 60 °C approx. 0.25m <sup>3</sup> /min	
CONNECTIONS / PIPES	Power outlet required	●	●	
	Water connection pressure	1 to 10 bar	1 to 10 bar	
	Power input	1,466–1,480W	1,466–1,480W	
	Connection limits	220–240 V/50 Hz	220–240 V/50 Hz	
ECO	EN 1717 (Drinking water safety)	●	●	

	WASHLET® RW	WASHLET® SW	WASHLET® RX EWATER+	WASHLET® SX EWATER+	WASHLET® RG	WASHLET® RG Lite**
						
	0,27 to 0,43l/min		0.27 to 0.43 l/min		0.27 to 0.43 l/min	
	0,27 to 0,43l/min		0.27 to 0.43 l/min		0.27 to 0.43 l/min	
	0,29 to 0,43l/min		0.29 to 0.43 l/min		0.29 to 0.43 l/min	
	●		●		●	
	unlimited		unlimited		unlimited	
	30 to 40°C		35 to 40°C		35 to 40°C	
	28 to 36°C		28 to 36°C		28 to 36°C	
	normal 0,09 m³/min, power 0,16 m³/min		normal 0,09 m³/min, power 0,16 m³/min		normal 0,09 m³/min, power 0,16 m³/min	
	37 to 55°C approx. 0,29 m³/min					
	●		●		●	
	1 to 10 Bar		1 to 10 bar		1 to 10 bar	
	1,455–1,468 W		1,437–1,459 W		1,482–1,495 W	1,480–1,494 W
	220–240 V / 50 Hz		220–240 V / 50 Hz		220–240 V / 50 Hz	
	●		●		●	

\*\* with hidden or side connections

# Possible combinations WASHLET® / WC

We have at least one compatible toilet for every WASHLET®. It's also possible to start with a toilet and upgrade to WASHLET® later on. Our overview has all the necessary details.

NEOREST®			
WASHLET® for NEOREST® WX2*	WASHLET® for NEOREST® WX1	WASHLET® for NEOREST® WX1 matt black	WASHLET® for NEOREST® WX1 matt white
TCF95280GEU	TCF95180GEU	TCF95580GEU#MBL	TCF95580GEU#MW

TOILET	WC for NEOREST® WX2*, wall-hung with circonium coating	CW928PZY	●			
	WC for NEOREST® WX1, wall-hung	CW927PZY		●		
	WC for NEOREST® WX1, wall-hung matt black	CW927PMZY#MBL			●	
	WC for NEOREST® WX1, wall-hung matt white	CW927PMZY#MW				●
	WC RP, wall-hung for WASHLET®	CW542ERY				
	WC RP, wall-hung for WASHLET® matt black	CW542ERY#MBL				
	WC RP, wall-hung for WASHLET® matt white	CW542ERY#MW				
	WC RP, back-to-wall, floor-standing	CW563Y#XW				
	WC RP, close coupled	CW561Y#XW				
	WC SP, wall-hung for WASHLET®	CW522ERY				
	WC GP, wall-hung for WASHLET®	CW553EY				
	WC GP, wall-hung	CW553Y				
	WC RP, wall-hung	CW552RY				
	WC ES, wall-hung	CW797				
	WC NC, close coupled	CW761Y				
	WC NC, wall-hung	CW762Y				
	WC NC, back-to-wall, floor-standing	CW763Y				

A compatible connecting set may be needed for the WASHLET®/toilet combination – depending on the toilet, it may be necessary to order additional parts.

For detailed information, please see our price list or our website: [eu.toto.com](http://eu.toto.com).







# PLANNING DATA

**WASHLET® RW / RW auto flush**  
**mat White**  
 incl. remote control

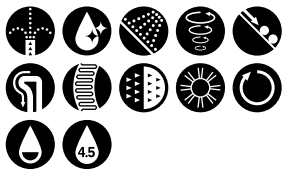
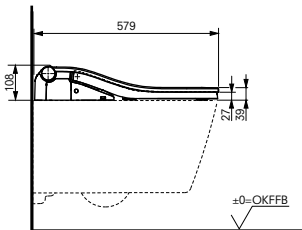
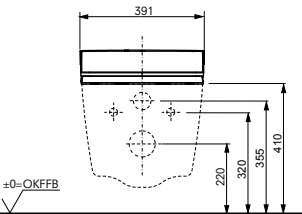
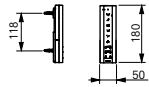
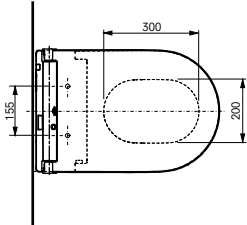

- ▶ TCF801ECG#MW
- ▶ TCF802ECG#MW (auto flush)
- ▶ CW542ERY#MW (WC)

**Required accessories:**

- Connecting set for WASHLET® with hidden connections SP10695UN
- or
- Mini Ball valve 3/8" for WASHLET® SP515011B

**auto flush:**

- Connecting set for WASHLET® with hidden connections SP10695UN
- Frame system for WASHLET® with automatic flush WH182EAT / WH183EAT for UK
- Push plate MB175M#W

**WASHLET® RW / RW auto flush**  
**mat Black**  
 incl. remote control

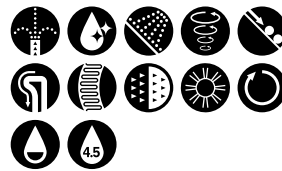
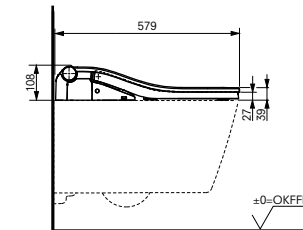
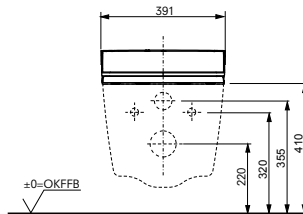
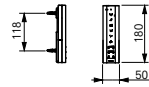
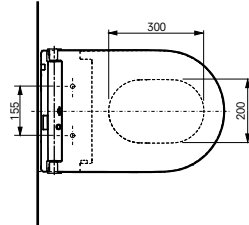

- ▶ TCF801EBG#MBL
- ▶ TCF802EBG#MBL (auto flush)
- ▶ CW542ERY#MBL (WC)

**Required accessories:**

- Connecting set for WASHLET® with hidden connections SP10695UN
- or
- Mini Ball valve 3/8" for WASHLET® SP515011B

**auto flush:**

- Connecting set for WASHLET® with hidden connections SP10695UN
- Frame system for WASHLET® with automatic flush WH182EAT / WH183EAT for UK
- Push plate MB175M#B

**WASHLET® SW / SW auto flush**  
 incl. remote control

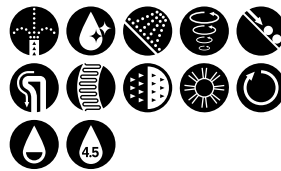
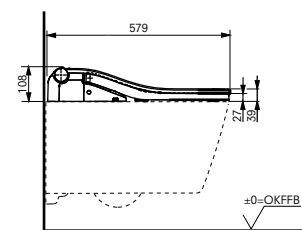
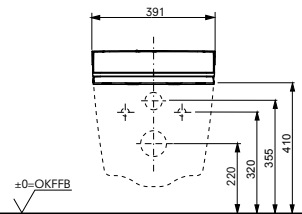
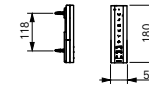
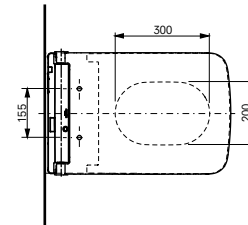

- ▶ TCF803CG
- ▶ TCF804C2G (auto flush)
- ▶ CW522ERY (WC)

**Required accessories:**

- Connecting set for WASHLET® with hidden connections SP10695UN
- or
- Mini Ball valve 3/8" for WASHLET® SP515011B

**auto flush:**

- Connecting set for WASHLET® with hidden connections SP10695UN
- Frame system for WASHLET® with automatic flush WH182EAT / WH183EAT for UK
- Push plate MB175M#SS



# PLANNING DATA

## WASHLET® RG Lite with hidden connections incl. remote control



## WASHLET® RG Lite with side connections incl. remote control

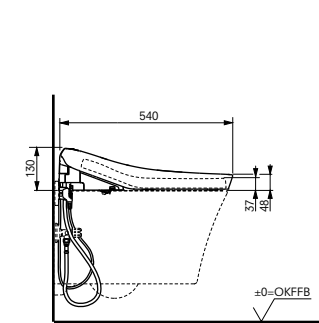
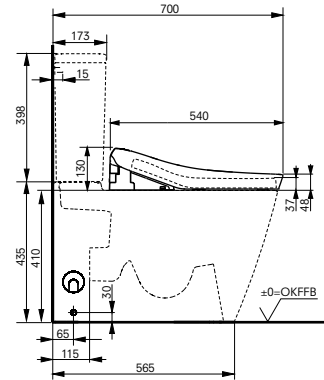
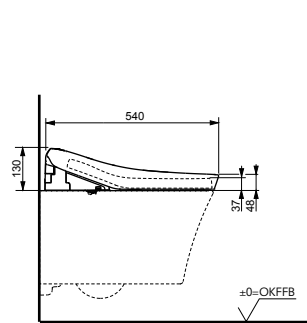
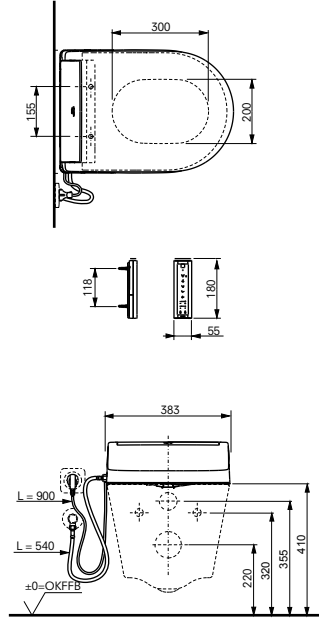
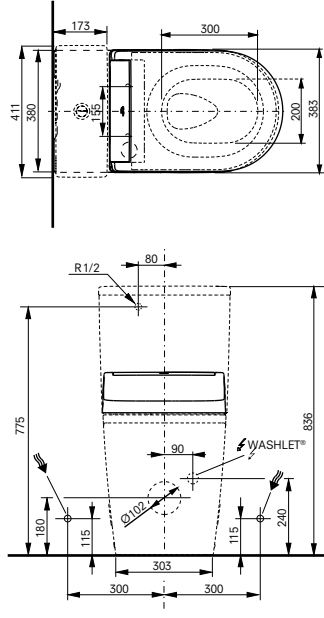
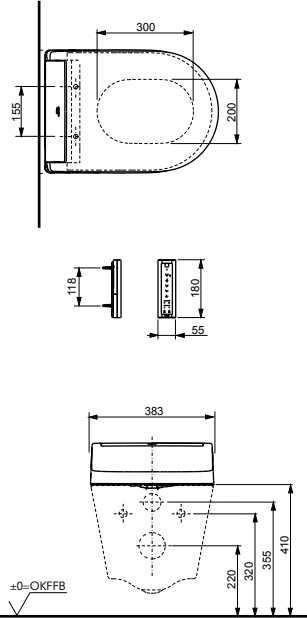

- ▶ TCF34170GEU
- ▶ CW553EY (WC wall-hung)

- ▶ TCF34170GEU
- ▶ CW561Y#XW (WC close coupled)

- ▶ TCF34120GEU
  - ▶ TCF34120GGB (UK)
- For compatible toilets, see p. 70/71.

### Required accessories:

- Connecting set for WASHLET® with hidden connections SP10695UN or
- Mini Ball valve 3/8" for WASHLET® SP515011B

### Required accessories:

- Ceramic cistern RP SW561DY#W
- Connecting set for WASHLET® RG / RG Lite with hidden connections on WC RP, close coupled TCA567

Depending on the toilet, it may be necessary to order additional parts.

For detailed information, please see our price list or our website: eu.toto.com.

## What you should know

### **What technical aspects do I need to consider?**

Your plumber and electrician need to provide extra power and water connections in advance.

### **Who can install the WASHLET®?**

Trained and certified plumbers are fully capable of installing shower toilets.

### **How can I find the closest plumber or retailer?**

You can find retailers and certified plumbers on our website ([eu.toto.com](http://eu.toto.com)).

### **Can I upgrade my toilet to a WASHLET®?**

If you have the necessary power and water connections, it is possible to upgrade at any time. Please consult this brochure to see which WASHLET® models fit on which TOTO toilets.

### **How can I decalcify WASHLET®?**

It's easy to decalcify your own WASHLET®. There are different options available depending on the model. For more details, please see the instructions for your model or our website: [eu.toto.com](http://eu.toto.com).

### **Where can I try one?**

Use the WASHLET® finder on our website ([eu.toto.com](http://eu.toto.com)) to see where the nearest publicly accessible WASHLET® model is located.

### **Why should I choose a WASHLET® from TOTO?**

TOTO produces the most technically sophisticated shower toilets on the market today.

# Publishing details

## Published by

TOTO Europe GmbH

[teu.info@toto.com](mailto:teu.info@toto.com)

[eu.toto.com](http://eu.toto.com)

Authorised representatives:

Tatsuhiko Yasaka, Managing Director

## Copyright

2025, TOTO Europe GmbH

“NEOREST” and “WASHLET” are

registered trademarks owned by TOTO Ltd.

## Last revised

January 2026

## Concept development, editing and design

PLEXGROUP, Berlin

TOTO Europe GmbH

## Picture credits

p. 40/41 © iStock/Vladimir Arndt

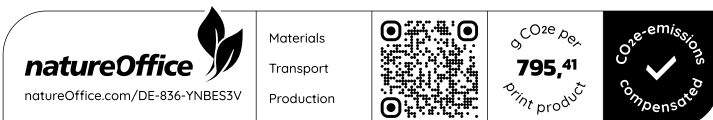

# Design Awards



## iF Design Award

Since 1953 one of the oldest, independent and internationally renowned design awards. It is held by the "iF International Forum Design GmbH" in Hannover, Germany. Products whose aesthetics, functionality, and innovativeness have been strictly examined and recognized by design experts.



reddot award

## Red Dot Award

An internationally renowned design award since 1955. Held at the "Design Zentrum Nordrhein Westfalen" in Essen, Germany. Products that have been strictly examined and recognized by design experts against standards as e.g. innovativeness, functionality and quality.



## Green Good Design Award

Hosted by American Chicago Athenaeon architectural design and European architecture Design City Research Center in Ireland. A global environmental award that began in 2009 with the aim of reforming awareness through sustainable design.

**Headquarters**  
**TOTO Europe GmbH**  
**Zollhof 2**  
**40221 Düsseldorf**  
**Germany**

**teu.info@toto.com**  
**eu.toto.com**

TOTO Europe GmbH  
140-142 St. John Street  
London EC1V 4UA  
United Kingdom

T +44 (0)207 831 7544  
teu.london@toto.com